



Schließfachschränke Intro + Resisto



Intro

8170/8270/8370
8470/8570/...



Resisto

8070/8270/8271
8472/8573/...

Der Stahlschrank. _____

C + P Möbelsysteme GmbH & Co. KG
Boxbachstraße 1
35236 Breidenbach (Germany)
info@cp.de

www.cp.de



A490777 | 2024-07-17

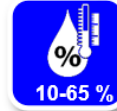
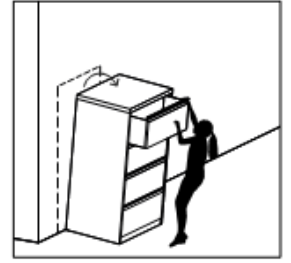
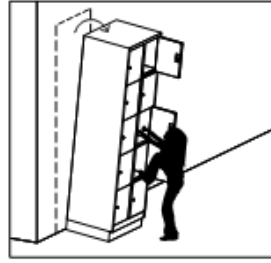
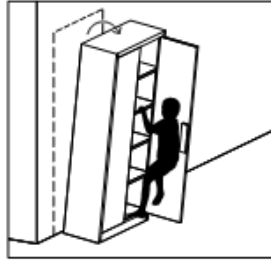
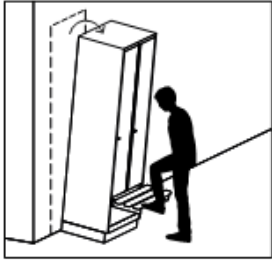

! WARNING

! WARNING



DE Wenn Möbelstücke umkippen, können schwerwiegende oder lebensgefährliche Verletzungen auftreten. Um das zu vermeiden, muss das Möbelstück sicher zum Beispiel an der Wand verankert und befestigt werden.

EN Severe or life-threatening injuries can occur if pieces of furniture topple over. A way to avoid this is to anchor and fasten the piece of furniture securely to the wall, for example.



Die dazu erforderlichen Schrauben und Dübel sind nicht im Lieferumfang enthalten. Verwenden Sie Befestigungsmaterialien, die für Ihre Wände geeignet sind. Bei Fragen zu diesem Thema empfehlen wir Ihnen, Fachgeschäfte vor Ort zu kontaktieren.

The necessary screws and dowels are not included in the scope of delivery. Use fastening materials suitable for your walls. If you have any doubts on this subject, we recommend consulting specialist stores in your area.

! AVERTISSEMENT

! WAARSCHUWING

! OSTRZEŻENIE

FR Lorsque les meubles se renversent, ils peuvent occasionner des blessures graves ou mortelles. Pour éviter cela, les meubles doivent être ancrés ou fixés de manière sécurisée, par exemple au mur.

NL Als meubels omvallen, kunnen er ernstige of levensbedreigende verwondingen ontstaan. Om dit te voorkomen, moet het meubelstuk stevig worden verankerd en bevestigd aan bijvoorbeeld de muur.

PL Przewrócenie się mebli może spowodować ciężkie lub zagrażające życiu obrażenia. Aby tego uniknąć, mebel należy przykręcić lub przymocować do ściany.

Les vis et chevilles nécessaires à cet effet ne sont pas fournies à la livraison.

Utilisez du matériel de fixation adapté à la nature de vos murs. Pour toute question à ce sujet, nous vous conseillons de contacter un magasin spécialisé près de chez vous.

De hiervoor benodigde schroeven en pluggen worden niet meegeleverd.

Gebruik bevestigingsmateriaal dat geschikt is voor uw muren. Als u vragen heeft over dit onderwerp, raden wij u aan contact op te nemen met plaatselijke speciaal-zaken.

Dostawa nie obejmuje potrzebnych do tego celu śrub i kołków.

Mocowania należy dostosować do rodzajuju ścian. W przypadku jakichkolwiek pytań na ten temat zalecamy kontakt z lokalnymi sklepami specjalistycznymi.

- IT
- ES
- PT
- CZ
- HU
- SE
- DK
- ...





				1
--	--	--	--	---

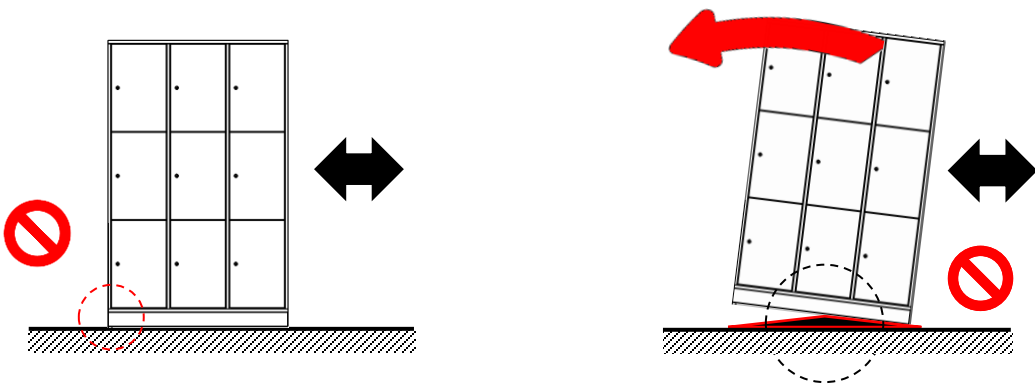
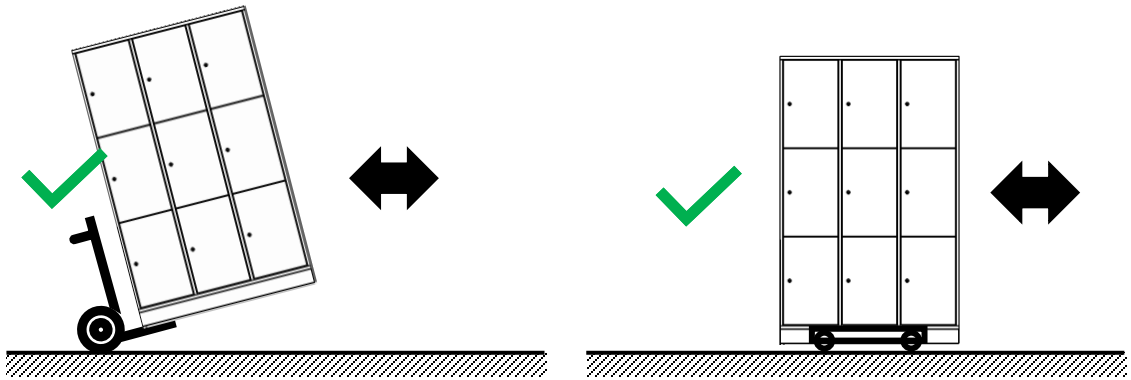

				2
--	--	--	--	---

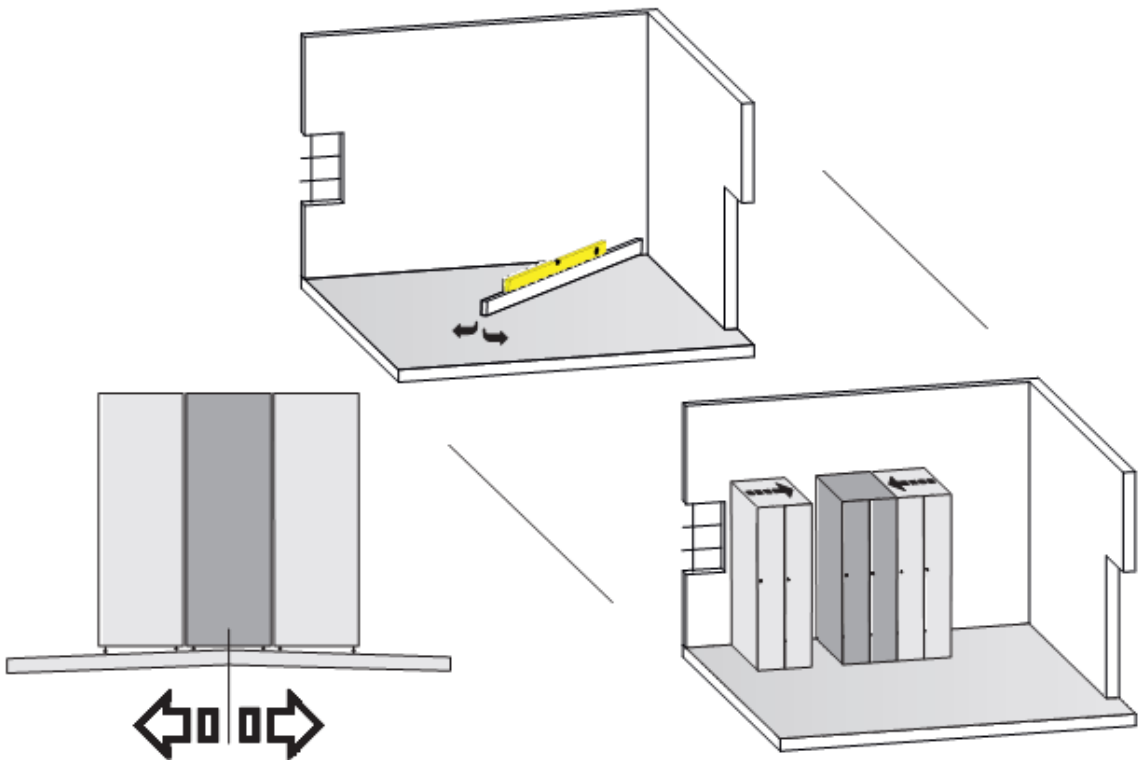



! WARNING ! WARNING ! AVERTISSEMENT ! WAARSCHUWING ! OSTRZEŻENIE

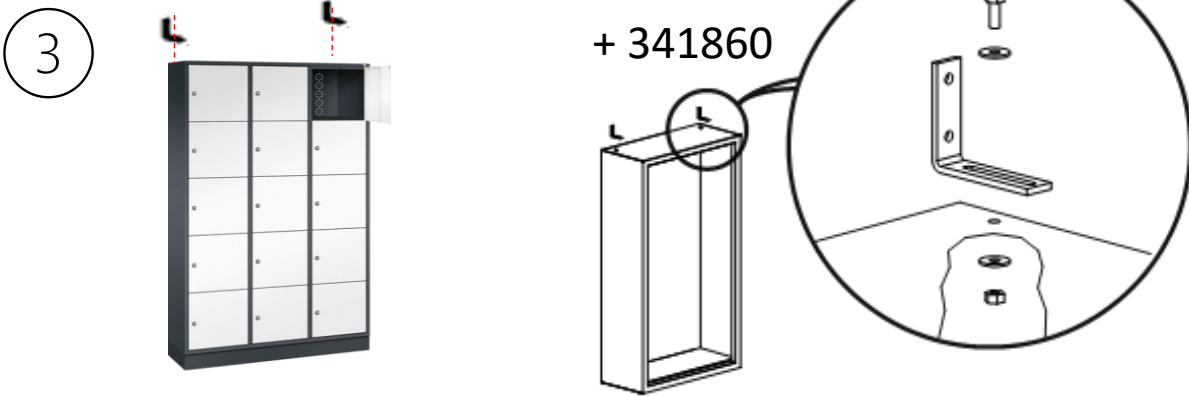
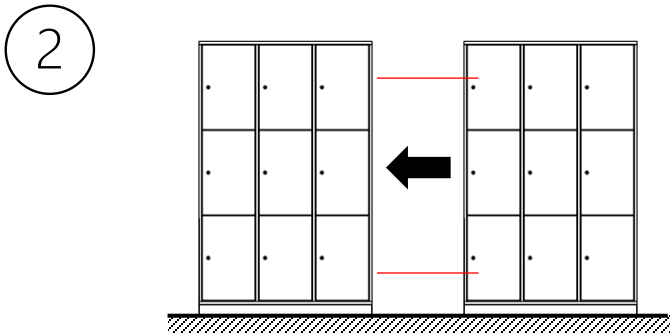
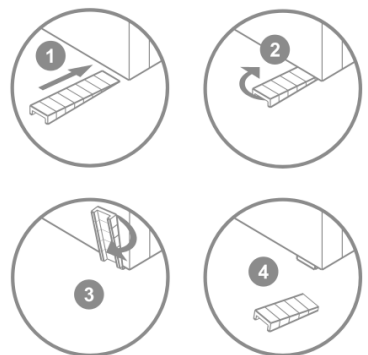
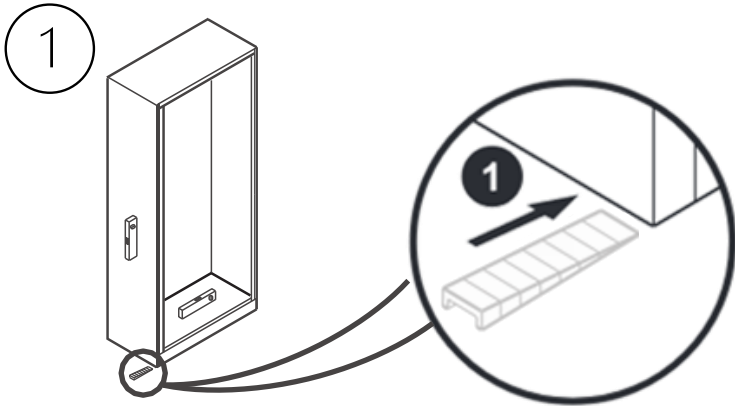
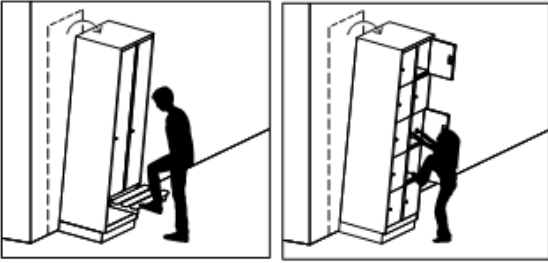



< Ø 6,5 mm
> Ø 8,0 mm



Ø 6,5 ... 8,0 mm



Zylinderschlösser
mit Schlüssel



Drehriegel für
Vorhängeschlösser



Mechanische
Pfand- und
Kassierschlösser



Mechanische
Code-Schlösser



Elektronische
PIN-Code Schlösser



Elektronische
RFID-Schlösser

Bezeichnung	Zylinderschlösser mit Schlüssel	Drehriegel für Vorhängeschlösser	Mechanische Pfand- und Kassierschlösser	Mechanische Code-Schlösser	Elektronische PIN-Code Schlösser	Elektronische RFID-Schlösser
Sicherheit	★★	★★	★★	★★	★★	★★★
Komfort	★	★	★	★★	★★★	★★★
Funktion	★	★★	★★	★★	★★★	★★★
Schloss-Typ	Mechanisch	Mechanisch	Mechanisch	Mechanisch	Akku	Akku / Kabel

Legende	★ = gut	★★ = besser	★★★ = optimal
---------	---------	-------------	---------------

Intro	•	•	•	•	•	•
Resisto	•	•	•	•	•	•
Spezial Lösungen	•	•	•	•	•	•

Legende	• = möglich	- = nicht möglich	bei Wünschen fordern Sie un
---------	-------------	-------------------	-----------------------------

Hier finden Sie die dazugehörigen Ersatzteile www.cp.de/service/ersatzteile



Ersatz-Teile

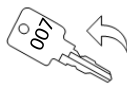

Einzel-/
Ersatz-
schlüssel



Einzel-/Ersatz-
schlüssel für
Hauptschlüssel-
anlage

Art.-Nr.:
99699-00000



C + P Der Reiniger

