

# Serie C3000 1460xx-xxx

*Asisto*



C+P Möbelsysteme GmbH & Co. KG  
Boxbachstraße 1  
D-35236 Breidenbach (Germany)



443981 / 2020-03-13





.....

4

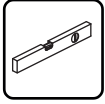

.....

5



.....

6

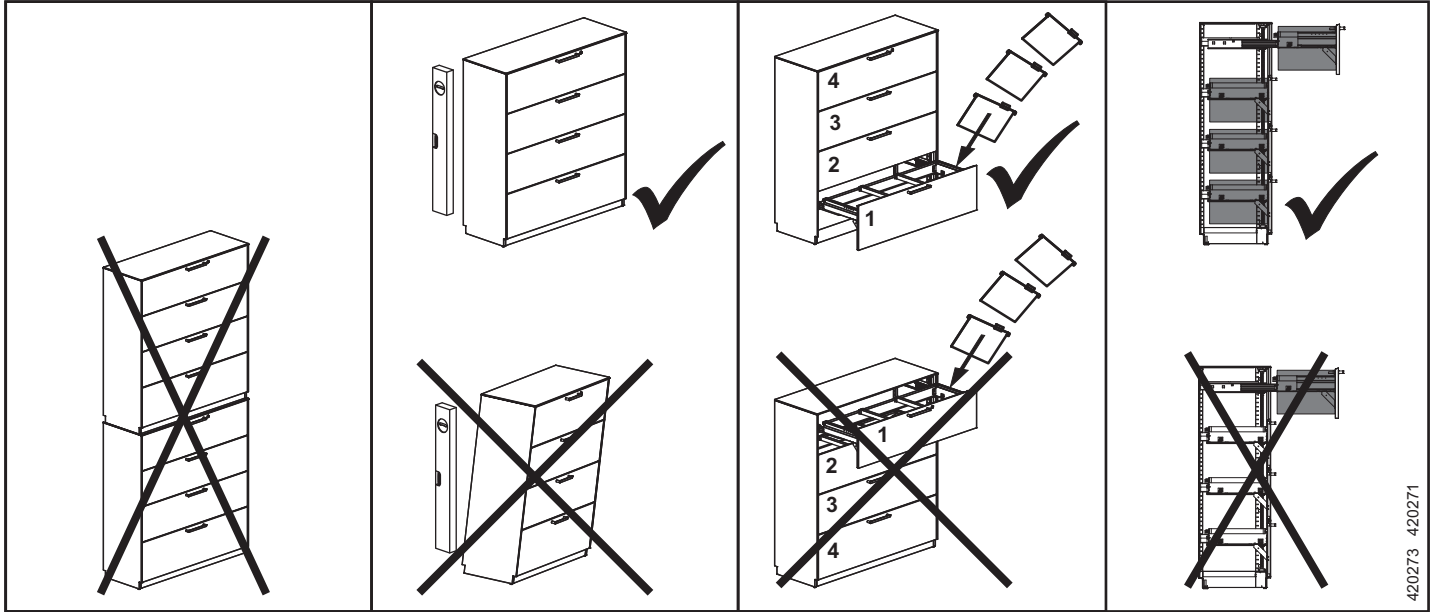

	 ← 800 →	 ← 1200 →	 ↓  Σ = ↓
	 50 kg	 50 kg	 Σ = 400 kg
	 50 kg	 50 kg	 Σ = 400 kg

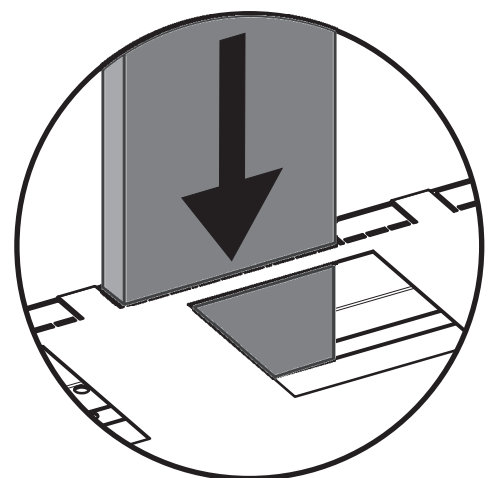
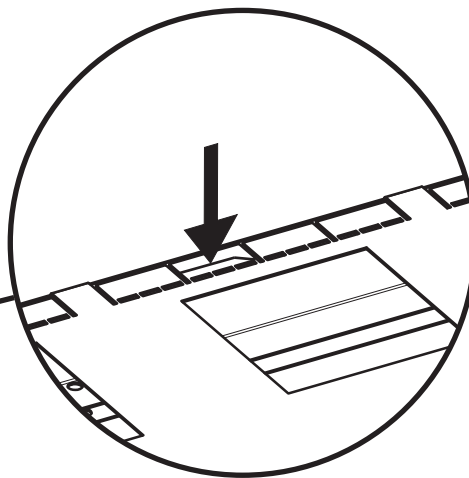
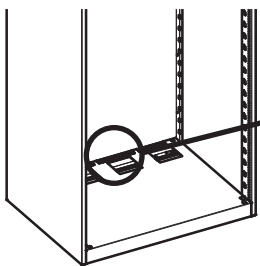
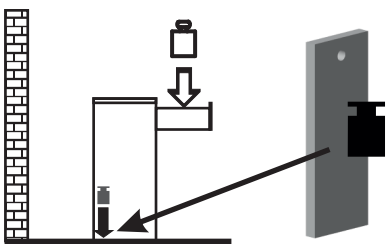
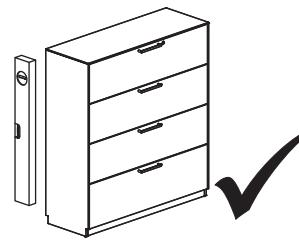
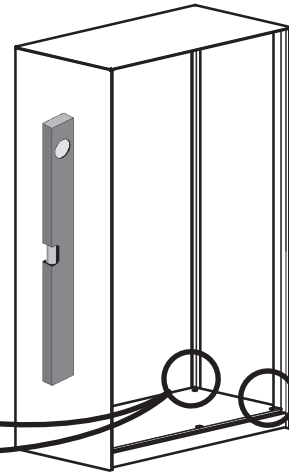
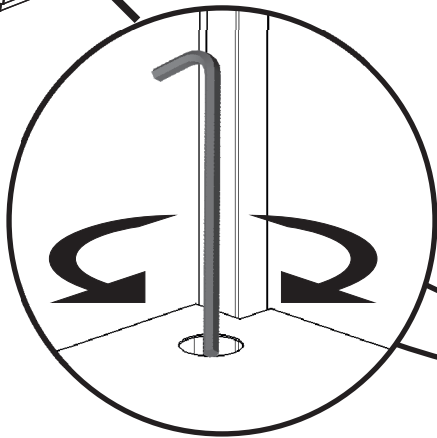
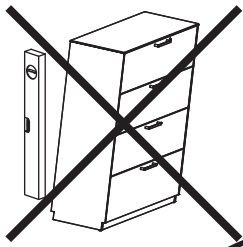
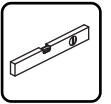



A		B		C		D		E	
2x		2x		2x		2x		2x	

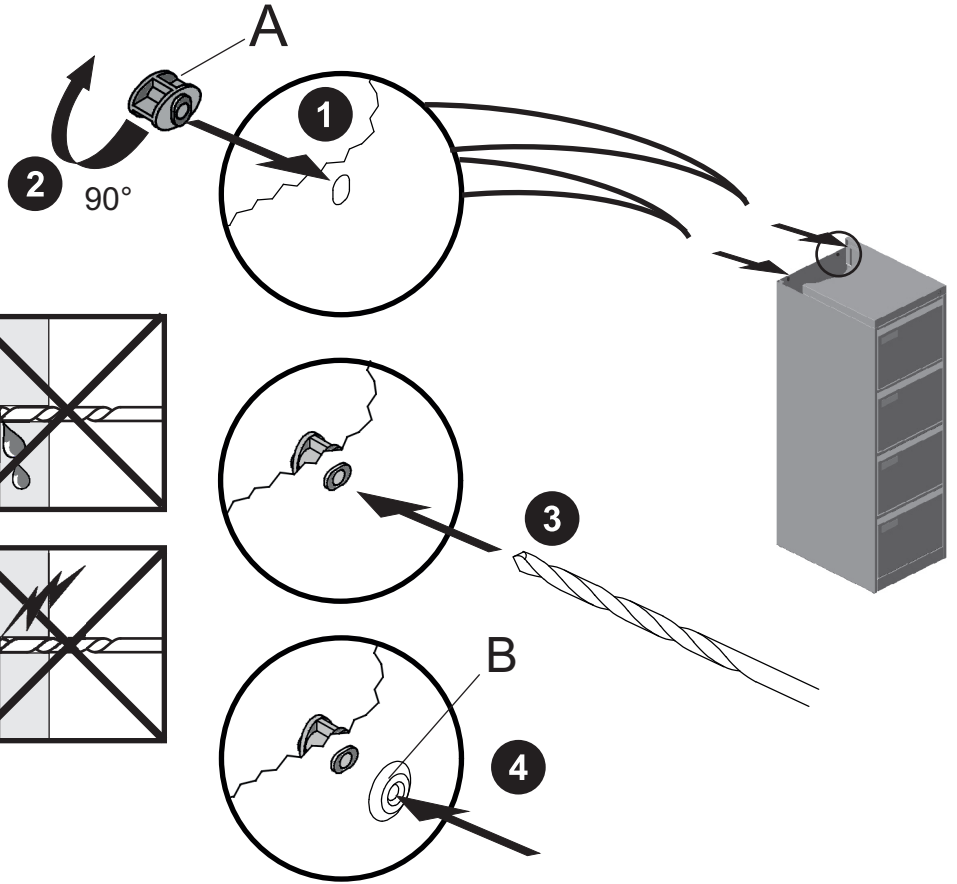
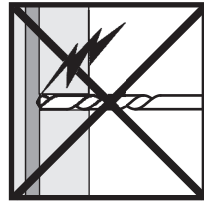
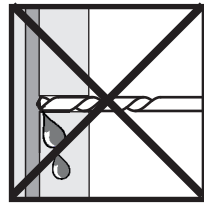
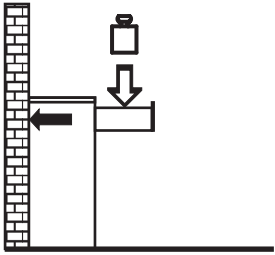
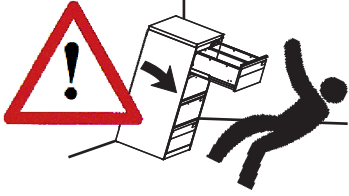

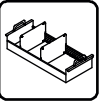

A									
2x									



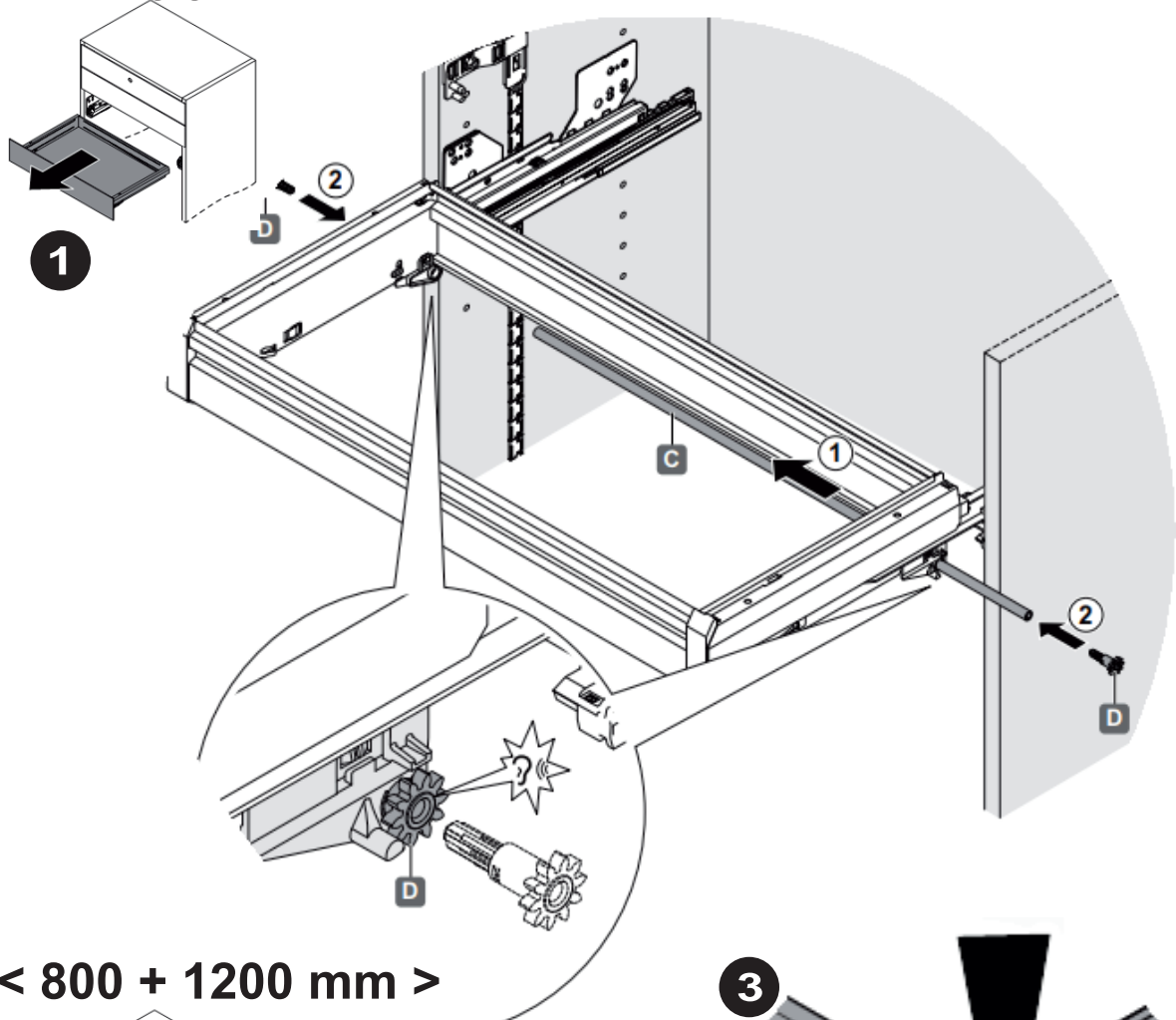



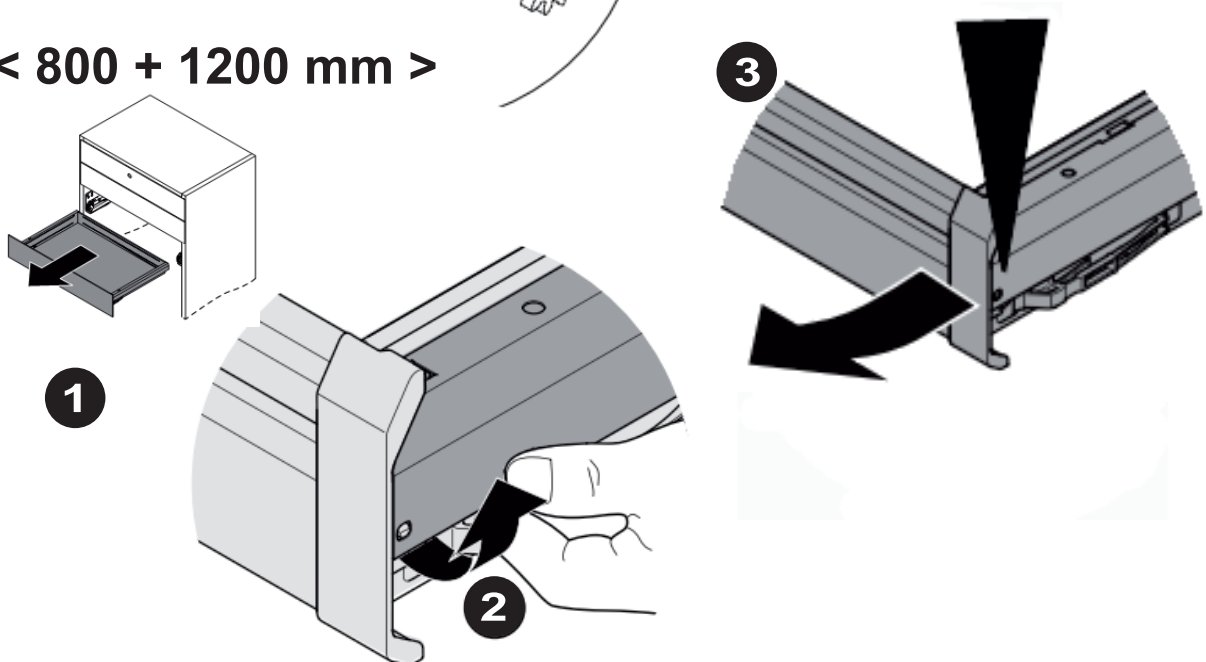

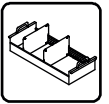
**< 1200 mm >**

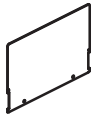

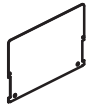



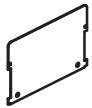

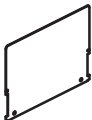
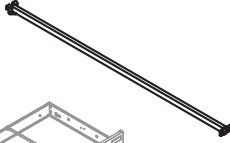
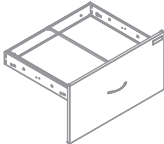

**< 800 + 1200 mm >**





	No.
DIN A4  	6494-10
DIN A5  	6495-10
DIN A5  	6495-20
DIN A6  	6496-10
 	6495-14
 	6790-030

	No.
 	6103-10
 	6103-11
 	6103-13
 	6103-12
	2025-02